



ELECTRONIC NAVIGATION CONSOLE

User Guide

User Guide for ENC3

© Copyright by Marine Tech SA

All rights reserved.

Disclaimer

This document is protected by international copyright laws.

The content is proprietary to Marine Tech SA ("Marine Tech"), and no ownership rights are hereby transferred. No part of this document shall be used, reproduced, translated, converted, adapted, stored in a retrieval system, communicated or transmitted by any means, for any commercial purpose, including without limitation, sale, resale, license, rental or lease, without the prior express written consent of Marine Tech.

Marine Tech makes no representations, warranties or guarantees, express or implied, as to the accuracy or completeness of the manual. Users must be aware that updates and amendments will be made from time to time to the manual. It is the user's responsibility to determine whether there have been any such updates or amendments. Marine Tech nor any of their directors, officers, employees or agents shall be liable in contract, tort or in any other manner whatsoever to any person for any loss, damage, injury, liability, cost or expense of any nature, including without limitation incidental, special, direct or consequential damages arising out of or in connection with the use of the manual.

Marine Tech accepts no liability for damages and/or injuries caused by improper use of the Seacraft ENC3 as well as a result of its use in a manner contrary to or deviating from principles set out in this manual.

Marine Tech accepts no liability for accidents and damage resulting from incorrect use of the ENC3 resulting from failure to read the ENC3 manual or lack of knowledge on the content of labels and pictograms, warning and information signs.

This manual is no substitute for a proper training in how to dive and navigate under water, with or without use of ENC3.
Should you have any questions or comments regarding this manual, please contact:

Manufacturer:

MARINE TECH SA

ul. Żwirki i Wigury 17
38-400 Krosno , Poland

Email: info@seacraft.eu

Web: www.seacraft.eu

Document Information:

Title:	Quick User Guide Seacraft ENC3
Document Version:	1.6.04
Software Version:	1.6.04
Publication Date:	10.04.2020

Table of Contents

1.	Technical specifications	6
2.	Precautions	7
3.	Mechanical construction	8
4.	Control	9
5.	Main screen layout	11
6.	Additional information screen (next to main)	16
7.	Destination parameters – setting and changing	20
8.	MENU screen	24
9.	Depth profile graph	27
10.	Swim route graph	28
11.	TIMER / stopwatch	30
12.	Device configuration (SETUP)	31
13.	Send data	32
14.	Pressure/salinity	34
15.	Log/speed	35
16.	Log/speed calibration	37
17.	GPS	41
18.	Time/date	42
19.	Other settings	43

20.	Units	44
21.	Compass	45
22.	Clear data	49
23.	Factory reset	49
24.	Exit	49
25.	Auxiliary software for Android® - installing	50
26.	Auxiliary software for Windows® - installing	51
27.	Using auxiliary software	52
28.	ENC3 firmware update	62
29.	Guidelines for attaching the ENC to DPVs	66
30.	Troubleshooting	68
31.	Before each dive...	70

1. Technical specifications

Model	ENC III	Power source	Built-in Li-ion 3,7 V battery
Type	ENC v.3	Battery capacity	5 Wh
Maximum depth	300 m	Typical working time	20-35 h
Tested depth	350 m	Average charge time	<2 h
Depth of start and stop of immersion time counting	Optional: 0.5, 1 or 1.6 m (compatible with the norm EN 13319)	Working temperature	+10 ... +45°C
Accuracy of depth measurement	0.3 m in the whole depth range, temp. range: 0...30°C	Storage temperature	-20 ... +45°C
Accuracy of compass	<5 degrees*	Temperature when charging	+10 ... +40°C
Accuracy of ext. log	<2%*	Mounting type	Universal
Possibility of using above the water level	up to 5000 m	Internal storage capacity	50 routes
Weight / displacement	290 g / -90 g	Length x height x width	95 x 71 x 30,6 mm

* The accuracy of the measurement depends on the quality of the calibration and the absence of external interference.

Included sensors: 3D magnetometer, 3D gyroscope, 3D accelerometer, pressure sensor, temperature sensor.

Satellite positioning: GPS, Beidou, GLONASS

Data exchange: via Bluetooth 4.2 and/or via USB cable.

Power source: Li-Ion battery cell 5 Wh. Device can use any 5 V DC power source as charger. When charging, it can consume up to 1 A current.

2. Precautions

This manual is suitable for the navigation device with software version 1.6.04 and above. The software version number is shown under **MENU**, when the battery voltage is displayed (**OFF** option selected).



WARNING !

This device may have some bugs in the software, which we did not find yet.

You should never risk your life using this device as sole advisor.

Electronic devices are designed for support and cannot substitute knowledge and training.



Waste disposal information:

This device contains Li-Ion cells and other materials, which must be recycled properly.

3. Mechanical construction

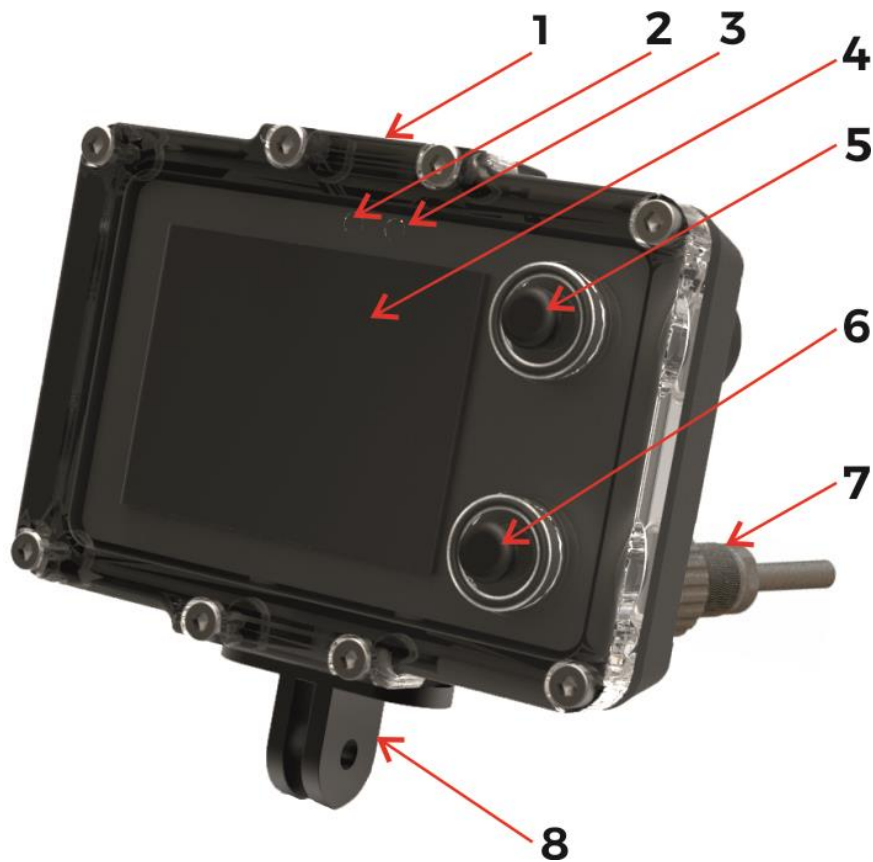

Fig. 1. Description of elements.

1. Universal mounting – top side
2. Ambient light sensor (do not cover)
3. Additional LED diode (red color)
4. Screen / display
5. Top button (NEXT)
6. Bottom button (SET, REC, HOLD)
7. External socket – for charging and speed sensor
8. Universal mounting – bottom side

4. Control

Button functions (depending on actual screen content):

Top button (5) – NEXT screen / NEXT item / CANCEL change / BACK

Bottom button (6) – SET / change value / enter changing item / switch between REC and HOLD state

Note



On most screens, a small graphical hint is displayed in top and bottom right corner of the display.

This hint is connected with the actual button function. It may be one of the below:



- Move cursor/selection down to next item



- Go to next screen



- Go to previous screen



- Select current item



- Cancel or delete



- Switch to next available value



- Increment current value by 1

First steps - switching on and off:

Switching on the device – press both buttons at the same time.

The device will also switch on when immersed in water min. 0.3 m (1 ft) deep.

Switching off the device – You have to stop recording first. Then go to MENU (from main screen –press the top button 3 times, then press the bottom button once). When the **OFF** command is selected, press the lower button.

The device will switch off automatically when the diving depth is less than 0.5 m and recording is off (HOLD).

Buttons operation - ENC buttons operating principle may seem strange for beginners. These are custom designed piezoelectric modules integrated into thick polycarbonate front-panel. Rubber "buttons" have indicative function only (easier operation in thick gloves).

Designing a non-magnetic solution that guarantees operation in very wide range of extreme pressures- **up to 300 m depth**- is not easy task, with ensuring reliability and simplicity. Some "getting used to" their operation is recommended, as ENC3 operating may be different from any other computer-style device you have used previously.

When diving, water pressure around this device is changing slowly all the time. Buttons cannot be sensitive for SLOW pressing/depressing. If so - only RAPID pressing can activate buttons. Thus, to activate button, quick "tapping" action rather than "pressing" is favored.

Modes of operation:

Normal operation mode – Default mode after power on. The user sees the current dive parameters, may switch recording ON (REC) and OFF (HOLD), enter settings and view the contents of the device's internal memory.

Charging mode – After connecting the device to a power source, the charging screen appears. The buttons are inactive in this mode. This mode will be terminated, when the battery is fully charged or the power source is disconnected.

Service mode – When a software update was requested, the device switches to this mode. The screen is blank and the LED above the display is blinking. This mode ends automatically after less than 1 minute.

5. Main screen layout

After power on, the device display will show this content:



Screen elements:

1. Course to planned destination. If no destination is programmed, this field is blank.
2. Present memory slot number. If you start recording, the dive data will be saved in the device memory with this number.
3. Small directional marker (described below).
4. GPS status marker (described below).
5. Time/distance to destination. These values alternate every 3 seconds. This field may be blank, if the corresponding value cannot be calculated.
6. Battery icon
7. Current compass heading (including programmed declination and deviation).
8. Present marker number. For using markers, please see next chapter.
9. Destination direction arrow. The tip of the arrow is always pointing to the planned destination. If no destination is set, this arrow will point to the North (just as 'normal' compass).
10. Present speed value and units. **mpm** means that the speed is displayed in meters per minute, **kts** stands for 'knots'. The symbol  means, that the external speed sensor should be connected to get valid distance/speed readings.
11. Total distance travelled.
12. REC/HOLD marker.
13. Present depth.
14. Total Dive time.

Buttons role:





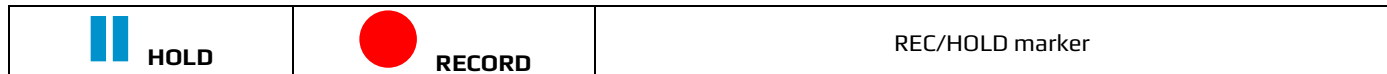

Top button – Switch to next screen

Bottom button – Switch recording between ON (RECORD state) and OFF (HOLD state). The icon in the right bottom corner shows the current recording state as described below.



NOTE - When the device is in RECORD state, the red dot symbol is animated.

Battery indicator

Icon	Charge on %	Time left	Icon	Charge in %	Time left
	85-100	20-25 h		28-45	5-10 h
	68-84	17-20 h		12-27	1-5 h
	46-67	10-17 h		1-11	<1 h

Caution: The value 'Time left' is approximate !

Navigation arrow colors:



White – Normal operation with or without programmed destination



Green – Destination is set and distance to it is less than 10 meters



Orange – The diver is returning to the start point (distance >10 meters)

GPS indicator:

Icon	Meaning	More info
A green circle with a white center and a white crosshair.	GPS location fixed	Good GPS readings are available. The GPS location reading is valid and accurate.
An orange circle with a white center and a white crosshair.	GPS location fixed	GPS readings are available, but the accuracy may vary due to low signal strength/quality.
A grey circle with a white center and a white crosshair.	No valid GPS location available	The GPS receiver cannot obtain the current location, but previous readings may be still available and valid.

Depth indicator colors:

Color	Meaning	More info
0.0	Vertical speed (up or down) is less than 9 m/min (29.5 ft/min)	No special actions required from diver.
9.5	Vertical speed (up or down) is equal or greater than 9 m/min (29.5 ft/min)	There is a noticeable depth change.
24.3	Vertical speed (up or down) is equal or greater than 19 m/min (62.3 ft/min)	The user should be aware, that ascending or descending at this speed may have negative health effects.

The vertical speed is calculated based on measurements taken in the last 3 seconds.

6. Additional information screen (next to main)

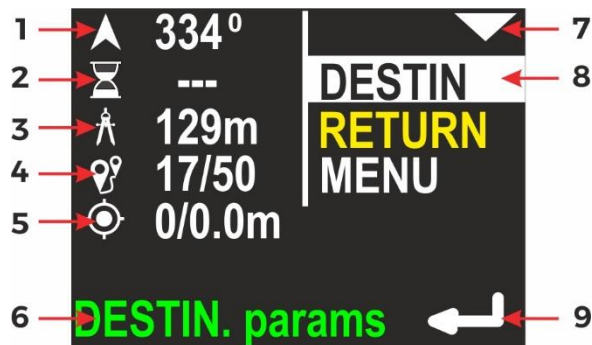

After pressing the top button on the main navigation screen, the display content changes like shown above.

On the left side of the screen, all present information are shown. On the right side there is a list with all available options. The currently selected item is marked by inverting the background and foreground color (highlighting).

In the picture above, first item (DESTIN) is selected, so left part of the display is filled with information connected to actual destination parameters:

- | | |
|--|---|
| <ul style="list-style-type: none">1 - Course to the programmed destination2 - Time left to destination (approx.), if can be calculated3 - Distance left to destination4 - Current record number in memory / maximum available records5 - GPS information: available satellites count / horizontal precision6 - Operation hint – when you press the lower button, you will be redirected to the screen with DESTINATION parameters | <ul style="list-style-type: none">7 - Top button role – go to the next (lower) item8 - Currently selected item9 - Bottom button role – enter/choose the selected item |
|--|---|

Note



If some of parameters cannot be evaluated, a '---' value will be shown instead.

RETURN function is unavailable (grayed) before you start swimming and went at least 20 meters from the start point.

Buttons role:

Top button – Select the NEXT item. After 3rd press, you will return to the main navigation screen.

Bottom button – ENTER to activate the selected item.

Note: If the destination parameters are cleared (not set), this screen looks like this:



If the RETURN item is selected, the screen looks like below:



- | | |
|--|---|
| <ul style="list-style-type: none">1 - The course you need to follow in order to return to the start point2 - The time required to return to the start point (approx.)3 - The distance from current location to the start point4 - Operation hint – when you press the lower button, the device will guide you back to the start point | <ul style="list-style-type: none">5 - Top button role – go to next (lower) item6 - Currently selected item7 - Bottom button role – enter/activate the selected item |
|--|---|

Buttons role:

Top button – Select the NEXT item (MENU).

Bottom button – Switch the device from navigating to DESTINATION to navigating back to the START POINT.

If the MENU item is selected, the screen looks like this:



- 1 - Internal date (DD.MM.YY)
- 2 - Internal time (hh:mm), in 24-hour system
- 3 - Water temperature
- 4 - Operation hint – when you press the lower button, other functions will be shown.
- 5 - Stopwatch

The description regarding the right display side is the same as on previous picture.

Note



If the STOPWATCH is running or was stopped with count > 0, the STOPWATCH value will also be shown in green color on this screen (see below).

7. Destination parameters – setting and changing

When you activate the DESTIN(ation) option on the additional information screen (see fig. 1 on p. 6), the device will show the current destination parameters (if set) or it will suggest new ones, as shown in the following picture:

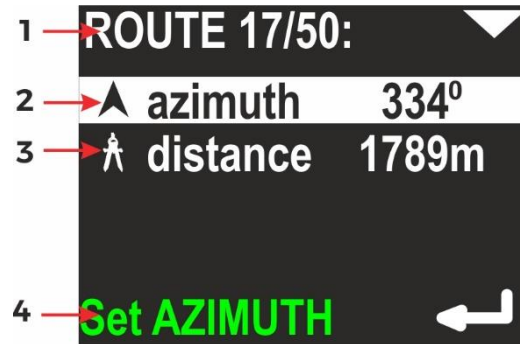

- 1 - Current route number in memory / total routes in memory
- 2 - Azimuth – planned course (including deviation)
- 3 - Distance – The distance to the planned destination
- 4 - Operation hint – When you press the lower button, AZIMUTH can be modified.

If you press the lower button (ENTER) when **azimuth** is selected, the display will change like this:

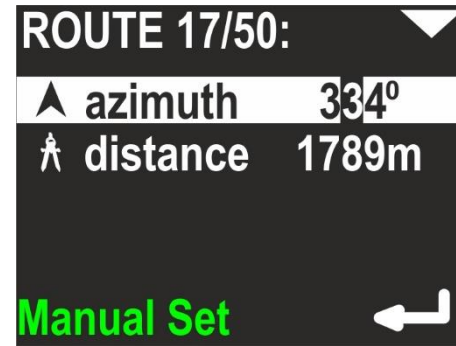
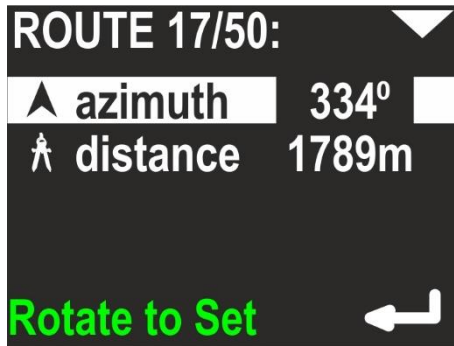

You may now rotate the device, in order to set the desired heading. Then simply press the lower button (ENTER), if the value is appropriate. You may also press the upper button now. This will allow you to set the desired **azimuth** manually digit by digit (use the lower button to change the value).

Next, set the distance – you may do it when the second line is highlighted:

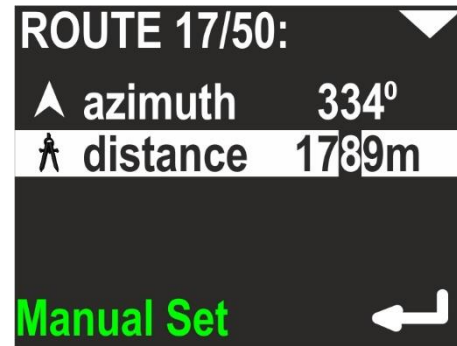
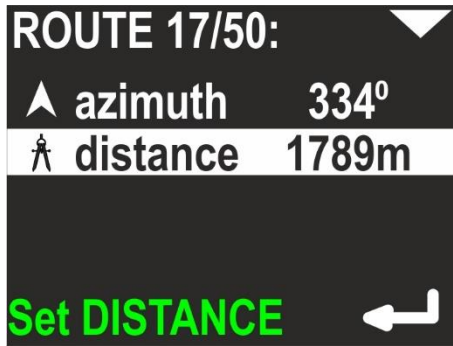

Distance value is changed also digit by digit. Pressing the top button switches to the next position, the bottom button changes the value

0 > 1 > 2 > ... > 9 > 0.

Note



The minimal allowed distance is 10m (or 0.01 mile). The device will not allow to set a shorter distance.

When both parameters (azimuth and distance) are set, pressing the top button will bring up the command line. You may choose from two commands, using the top button:

NAVIGATE – Apply values and switch to main screen (with destination)

CLEAR DESTIN(action) – Clear all values and switch to main screen (with no programmed destination)



Notes



The DESTINATION, once set, is held in memory until cleared or changed (power off will not clear programmed values).

The DESTINATION is always set or changed relatively to the current position.

8. MENU screen

If you press the lower button (ENTER) when the MENU item is highlighted on the additional information screen (see fig. 1 on p. 6), you may choose between 4 commands:

OFF – Allows you to switch off the device. The left part of the screen shows information about the present battery charge. Below that you see the device serial number (SN) (unique device identifier) and the internal software version (SV), as illustrated below:

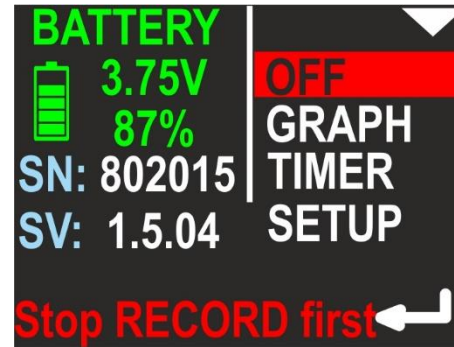
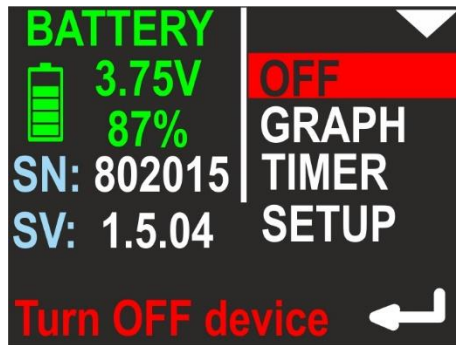

Note



You cannot switch off the device in the recording state (Hint: **Stop RECORD first** in bottom line – right picture). This prevents the user from accidentally switching-off the device.

GRAPH – Allows you to show the position and depth graphs on the device screen. More info about graphs can be found in chapter 9 and 10. On the left side of the screen, the device shows 2 numbers: Current routes in memory / maximum routes in memory. More about memory organization can be found in chapters 9 and 10.

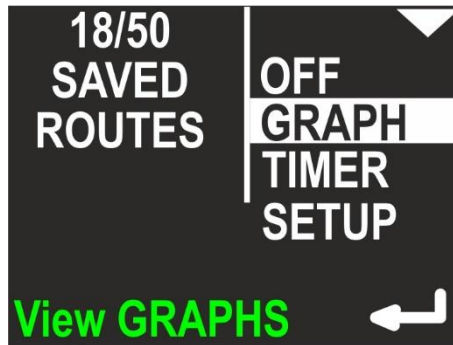

TIMER – Allows you to start, stop and clear the internal stopwatch. The stopwatch is described in chapter 11.



SETUP – This allows you to show and change all internal configuration parameters. More about this function can be found in chapter 12. On the left side on the screen, the most important settings are shown in short form (to avoid unnecessary activation of the configuration just to check it).

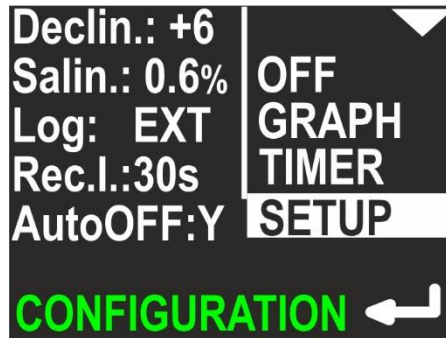

9. Depth profile graph

If you press the lower button (ENTER), when the GRAPH item on the MENU screen is highlighted, you will be redirected to the simple graph browser. The first available graph is called 'depth profile' and contains a representation of dive depth vs time, as shown below:



- 1 - Top button role (now - go to next graph: swim route graph)
- 2 - Time of first recorded data (hh:mm, 24-hour system)
- 3 - Date of first recorded data (DD.MM / YYYY)
- 4 - Average depth (if it can be evaluated)
- 5 - Maximum depth (if it can be evaluated)
- 6 - Route number in memory (blue) and lower button role (now - go to the next route number)

Note:

- The internal device memory stores all dive data identified by 'route number'. When the device is switched on, the least available (empty) route number is chosen for recording current data. If all available route numbers (1-50) are used, the oldest one will be overwritten.
- Data recording can be paused (HOLD state). The graph above does not show these breaks.
- You may tilt device to left or right to change the button roles on this screen. When tilted left, the lower button switches to the previous route number. When tilted right, the lower button will allow you to delete the current route.
- If the recording time is less than 1 minute, the record will be deleted when the device is switched off.

10. Swim route graph

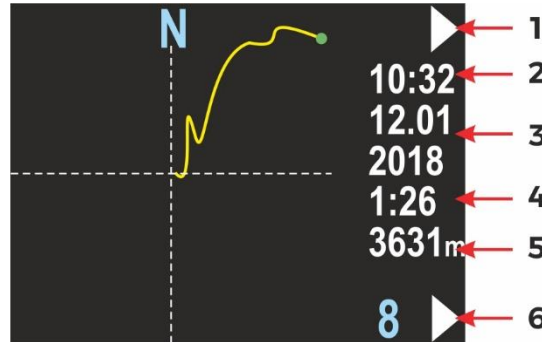

This screen presents the changes in the diver location projected on a flat surface (like on a map). The route start point is always positioned in the screen center. The route end point will be shown as a green dot, but only on the present route. Near the right edge of the screen, you will find some information elements:



- 1 - Top button role (now – go to next screen: return to main menu)
- 2 - Time of first recorded data (hh:mm, 24-hour system)
- 3 - Date of first recorded data (DD.MM / YYYY)
- 4 - Total recording time, in minutes (above 2h, this value will be shown in hours), may be blank, if the value cannot be calculated (empty record)
- 5 - Total distance in meters (above 2000m in kilometers), may be blank, if the value cannot be calculated (empty record)
- 6 - Route number in memory (blue) and lower button role (now – go to the next route number)

Note



You may see small GPS symbol above the record time, if this route has also any valid GPS readings recorded.

You may tilt the device to the left or to the right, in order to change the button roles on this screen. When tilted left, the lower button brings you to previous route number. When tilted right, the lower button will allow you to delete the current route. When tilted left, the upper button brings you to the previous graph (depth profile). This can be done on both graph screens :

Buttons role	Device tilted left	Device in normal position	Device tilted right
			
Top	Previous screen	Next screen	Next screen
Bottom	Previous route (10→9→8...)	Next route (4→5→6...)	Delete current route

Note



Before current route deletion there is always warning screen "**Are you sure to delete current route**". You may cancel this operation by clicking "**NO**" (upper button).

11. TIMER / stopwatch

If you press the lower button (ENTER) when the TIMER item on the MENU screen is highlighted, you will be redirected to the TIMER/STOPWATCH control screen:

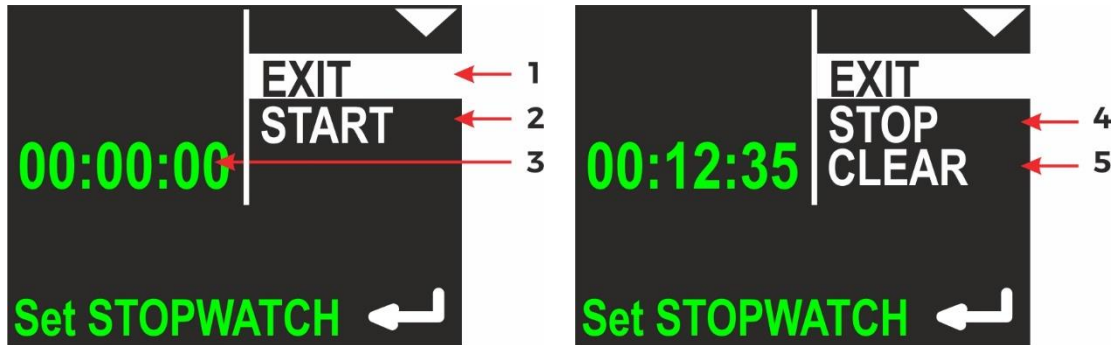

- 1 - EXIT – current selected command; if you press lower button (ENTER), you will return to main navigation screen
- 2 - Timer START – option to start TIMER/STOPWATCH for counting
- 3 - Current TIMER/STOPWATCH value (up to hh:mm:ss – hours: minutes: seconds)
- 4 - Timer STOP – option to stop TIMER/STOPWATCH
- 5 - Timer CLEAR – option to clear TIMER/STOPWATCH

If TIMER/STOPWATCH is running, there will be options to STOP and CLEAR its value. STOP will leave the TIMER/STOPWATCH value unchanged (you will be able to start it again and continue counting). CLEAR will set the TIMER/STOPWATCH value to 00:00:00, but the stopwatch will not be automatically stopped with this command.

12. Device configuration (SETUP)

If you press the lower button (ENTER) when the SETUP item on the MENU screen is highlighted, you will be redirected to the SETUP menu. Device settings are organized in 2 screens. The selected function is highlighted. The top button (NEXT) will switch the selected function to the next one (below). The bottom button (ENTER) will activate the selected item.



13. Send data

Used to activate the internal Bluetooth transmitter and allow USB connection. Activate it before any data transmission from the navigation device to a PC or smartphone. When this function is activated, the device will not power off automatically (except when the battery is low).

In data transfer mode, device screen looks like this :

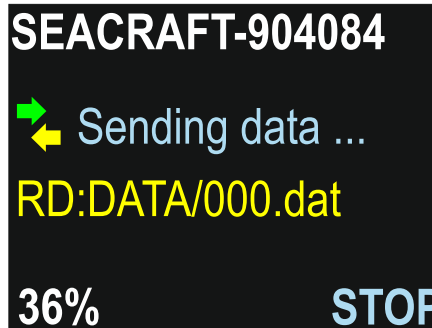

First line shows device name – the same name you will see in Bluetooth environment.

Green and yellow arrows will change to gray color, when transmission was broken.

Yellow text describes current operation (RD = reading, then file name).

In left bottom corner you will see progress indicator, in %.

You can always break communication by pressing lower ENC3 button (STOP).

CAUTION – If you want to use USB cable for data transfer, you should first enter in the 'Send data' mode and then connect the cable to the device and to your PC.

If you first connect the USB cable to the PC, device will switch to charging mode and data transfer will not be possible.

Note



If data transfer hangs, you can STOP transmission. ENC3 will reset (switch off and start from the beginning). You will have to enter the 'Send data' menu item again. You may also have to disconnect the USB cable, if you was using it for connection (see previous explanation).

IMPORTANT – when you updating ENC3 firmware and you have to break this operation, ALWAYS use STOP button on ENC3 device first (before closing program or PC/mobile device).

Note



When connecting your ENC3 console to the PC using USB cable, first time you will see message "New device found" and you will have to wait, until proper drivers are installed (internet connection may be required for this). After that you will able to use data transfer via USB cable.

If you will have any problems with device driver installation, please ask our support (office@seacraft.eu). We will help you to find the solution.

14. Pressure/salinity

Shows the current pressure in milibar (green color). 1 PSI \approx 68,95 milibar. When no pressure is shown, the pressure sensor is defective.



The lower line shows the pressure correction (white color) – this value will be added to the raw value of the measured pressure. It has no effect on depth calculations, but the value will be added to the pressure measurement shown above, so the user may calibrate this device as a precision barometer.

The last line allows to set the water salinity from 0.0% (fresh water) to 4.0%. This coefficient affects the pressure-to-depth transformation and should have an appropriate value.

When the item is highlighted, pressing lower button will allow to edit its value.

15. Log/speed

This navigation console can work with an external sensor (speed sensor) or without it (inertial mode). This option can be used to switch between these two modes.

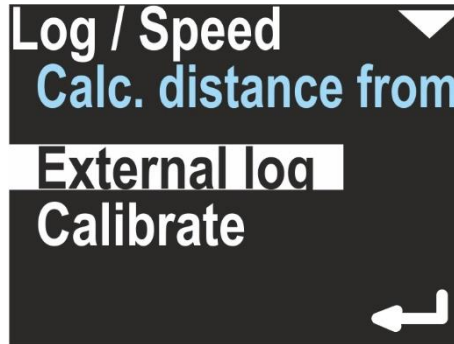

The field 'Calc. distance from' may switch between 'External log' and 'Const. speed'. The first value needs an external speed sensor (log) to be connected. If chosen, on the right side of the main navigation screen, this icon will be displayed: 

The option 'Calibrate' may change its coefficient, which is used to convert sensor pulses into speed and distance:

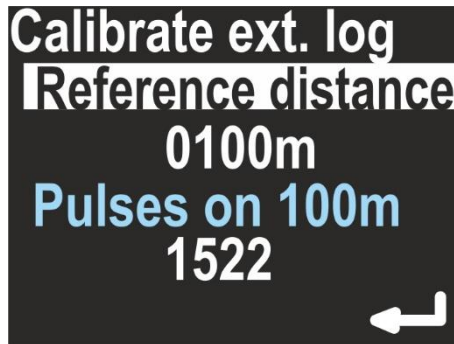

If you want to recalibrate the sensor, set the chosen distance in meters (reference distance) by pressing the lower button and changing the value digit by digit. Then, you will be guided to the next item, which shows how many pulses are counted in a distance of 100m. By pressing the lower button again, a new calibration begins:



EXIT
Press **START**
and swim exactly
1100m
START



EXIT
Press **STOP**
when reached
1100 m
000000
STOP

Press **START** and swim straight with no depth change, until the chosen distance is reached, then press **STOP**. The display will show you, how many log pulses were counted. If no pulses were logged, the calibration will be rejected.

When 'Calc. distance from' is set to 'Const. speed', a constant average speed is chosen to calculate the position (on the main screen, no log symbol is visible).

The option 'Calibrate' will allow you to set a constant average speed used to calculate the current position, the return time and the target time.



16. Log/speed calibration

ENC3 operation is different with and without external log sensor. Thus, the 'Calibrate' command has also different meanings, depending of the actual sensor settings.

When the external sensor is not used (**Calc. distance from = Const. speed**), the calibration means to choose an average swimming speed. When the device is in HOLD state, the distance counter does not change. When the user switches the device to RECORD state, the navigation console expects the user to swim with constant speed equal to the value set in this option (e. g. 50 m/min).

This type of operation requires from the user:

- Setting the average swim speed very precisely
- Swimming at constant speed
- Switching between HOLD and RECORD state as quick as possible

When the external sensor is used and connected to the device (**Calc. distance from = External log**), the calibration is used to get the best possible distance measurements. The sensor principle of operation is based on pulse counting. The sensor calibration factor equals the number of pulses which the speed sensor will produce while swimming a 100m distance.

A typical value is 1590 pulses on a 100 m distance. In most cases this value will be between 1400 and 1600 pulses on a 100 m distance.

Pulses value can be altered by type of DPV, mounting position, and influence of for example “propeller suction” effect. Devices are calibrated to be used with Seacraft scooters, which construction allows for optimal sensor placement, and minimizes interferences. While for general orientation underwater factory setting will be fine with most types of DPV’s, for more precise applications- as for example mapping- we recommend speed log calibration with whole set-up used.

This calibration factor depends also on the exact sensor position on the DPV. To get best results, mark the sensor position on the DPV body and perform the calibration procedure as described below:

- Mark the START and STOP point on a straight, known distance (100-1900 meters)
- Go to **SETUP -> Log/Speed -> Calibrate log** (make sure **Active log** is set to **EXT**)
- Enter the known calibration distance in the field **log at: ...**
- Below, you will see the actual calibration factor **log 100 m: 1590**. Make sure, the arrow points to this line, and press the lower button.
- The screen will show the message **Press START and swim exactly m**
- Go to START, set the favorite speed on your DPV, press START (lower button) on the navigation console, and swim as straight as possible to the STOP point. The screen display will show the pulse counter, which should increase with time.
- When you reach the STOP point, press the lower button again. The new log calibration factor will be shown on the screen.

Caution: The calibration procedure will fail, if the pulse count recorded during the procedure is far too low. In this case, the previous value will be shown in the calibration factor field (**log 100 m:**)

The calibration procedure needs values in meters. No other units are available. 1 N.M. (Nautical Mile, U.S.) equals 852.0 meters. 100 feet equals 30.48 meters. 100 meters equals 328.08 feet.

It is possible to set the calibration factor also without a need to dive and measure a known distance underwater. In case that logged route indicates deviation of covered distance - and currents presence or wrong mounting/ log damage are not a reason of that, the correct calibration factor "f" can be calculates using following equation:

$$f = \frac{ab}{c}$$

where:

a = length of the section as measured with ENC3

b = current calibration factor (pulses / 100 m)

c = precise known length of the route section

For example: the section being measured has a length of exactly 127 m and ENC has indicated the route length of 124 m. The entered and used in the ENC calibration factor is 1590 pulses / 100 m.

$$f = \frac{124 \times 1590}{127} = 1555$$

After entering the calibration function on the 100 m section, press START and to blow, or use for example a fan until the number 1555 appears and then press STOP. The correct calibration factor will be saved. The above operation is not complicated and takes very little time.

This function may be useful if various configurations of speed sensor are used, and you write down also various calibration factors- corresponding with given set.

Note



The log is a precise and delicate mechanical element and in the case of its significant contamination, after mechanical impacts or after changing the environment (fresh / sea water) it is recommended to check its early work and / or recalibration.

There are 2 types of log sensor : classic (type B) and compact (type C). In the future may be even more. If you have the classic log, a value between 1550 and 1600 in the calibration field should be good for you. With the compact sensor, you should have good results when the calibration is between 1600 and 1650 pulses/100m.

17. GPS

This menu option is for information purposes only. When selected, the navigation screen will show the GPS status information as described below:

- **Valid: Y/N** – Displays, if GPS information is available now
- **Sat.cnt: 0...15** – Number of satellites used to calculate the position (more = better)
- **Latt. N/S 0.00000°** - Latitude in degrees, can be **N**(orth) or **S**(outh)
- **Long. E/W 0.00000°** - Longitude in degrees, can be **E**(ast) or **W**(est)
- **Alt. 0.0** – Altitude, meters above sea level
- **D 0.0** – Horizontal deviation, always in meters (the lower, the better)

Note: When **Valid** is set to **N**, other values can be 0 (if no valid GPS readings were obtained during the last 30 seconds) or the value might display the last valid readings. When **Valid** is set to **Y**, values equal the present reading.

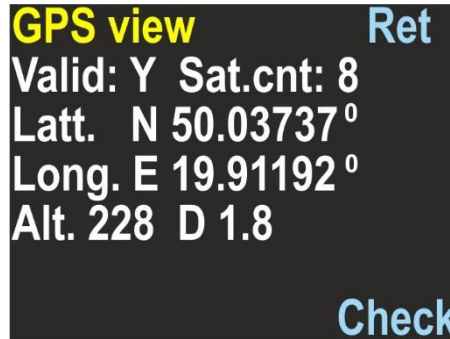

GPS information is refreshed automatically after each successful update on this screen.



The GPS state is also reported as icon on the main screen.

The GPS receiver is automatically switched off, when the water depth is 1.5 m (4.9 ft) or more, in order to save battery. When the water depth is 0.5 m or less (1.6 ft), the GPS receiver is switched on automatically.

After power on, first GPS readings should be available after 20-60 seconds. The GPS antenna is located between the buttons, so you should not cover this point with any objects.

You may tilt the navigation console as far as possible (screen upwards) for a while, to achieve better/quicker GPS readings, but this is not necessary in most cases.

18. Time/date

This device provides an internal real time clock with calendar.

The time format is 24 hours, the Date format is DAY.MONTH.YEAR. YEAR has only 2 digits. The value 01 means the year 2001, 02 means 2002 and so on.

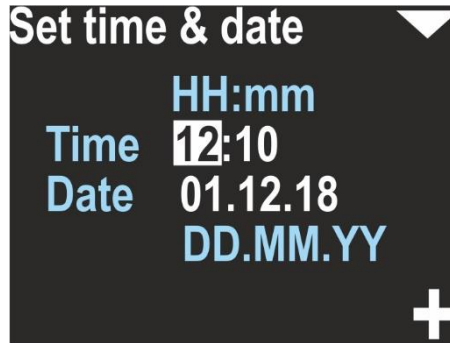

Caution:

- The device may drop date & time settings, if the battery was deeply discharged.
- The device clock accuracy is about 15 seconds per month. You may need to correct date & time settings from time to time.
- Date and time are used in record files. If date/time settings was lost, device will set date and time to 2019-05-01 12:00.

19. Other settings

Miscellaneous other settings are available as a separate screen:



Backlight – [1, 2, 3, 4, 5, auto] – Changes the display backlight intensity. Value 1 means the constant lowest brightness (about 20%), value 5 means the constant maximum brightness (about 95%), value 'auto' means that the backlight will be auto adjusted using the ambient light sensor.

Record every [2 s, 5 s, 10 s, 30 s] – This is the maximum available time space between two records in memory. Note, that in some cases two records may be collected faster than this value, but never longer.

Depth threshold [0.5 m, 1 m, 1.6 m] – The navigation console will count 'underwater time', when the depth is equal or greater than this value.

Auto-ON [yes/no] – If yes, device will switch on automatically when immersed in water by at least 0.3 meters (1 ft.).

Auto-OFF [yes/no] – If yes, the device will automatically power-off, if the water depth is less than 0.5 meters, RECORDING is OFF (HOLD state), and the user did not press any button during the last 5 minutes.

20. Units

Allows you to choose the units of the values presented on the screen:

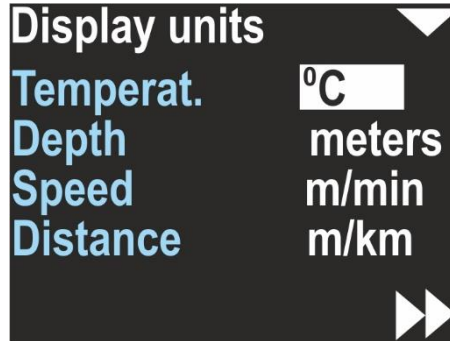

Temperat.(ure) – Can be °C (Celsius) or °F (Fahrenheit)

Depth – Can be meters or feet

Speed – Can be m/min (meters per minute) or knots (nautical miles per hour)

Distance – Can be m/km (meters and above 2000 m kilometers) or US.NM (United States Nautical Mile; 1 US.NM = 1852m)

The selected unit is usually displayed near the values on all other screens.

21. Compass

Allows to calibrate the magnetometer (compass sensor) and to set the magnetic declination and deviation.

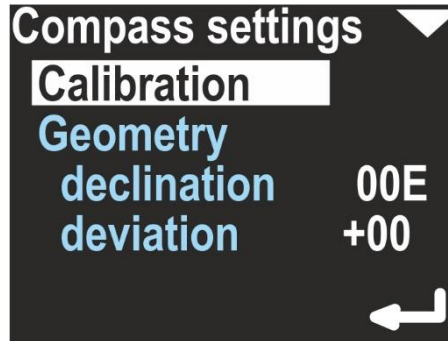

Calibration – This option is used for basic magnetometer calibration. You should use this function, when the compass direction shown on this device is improper. This is usually needed when the magnetic properties of the environment have changed.

In every location, magnetic background, declination and other magnetometer-influencing factors are different. Thus, the compass should be calibrated every time, when the location is changed, especially when there are big distances travelled (travelling to another continent, or to a distant country).

Activate this function, and rotate the device slowly in all possible directions in 8-shape. This should take at least 1 minute. A green progress bar will be shown on the screen. The lower button will be marked as BACK until the progress is less than 100% (time <1min). Pressing this button stops this operation, and no calibration data will be changed. After 1 minute, the lower button will be marked as SET, and pressing it will cause to apply the new collected calibration values to the compass sensor.

Caution: The new calibration can be worse than the existing. If you are not happy with the results, calibrate the compass again or restore the factory settings. After the basic calibration, you should set declination and deviation to 0 (zero), clear the precision calibration (see below), and set it again.

Geometry – This option allows a precision calibration. When activated, it will show you 8 coefficients. In an ideal case, when no distortions are present, this coefficients should be: 0, 45, 90, 135, 180, 225, 270 and 315. This option allows to achieve best compass accuracy (~1°). Without it, the compass accuracy can be 3-5° depending on the calibration quality (described above).

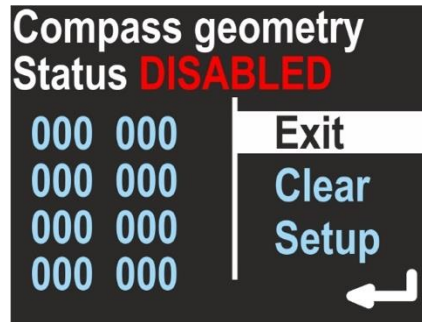

Use the top button to change the option:

Exit – Return with no changes

Clear – Switch off the precision calibration and clear all its coefficients

Setup – Make a new precision calibration

To make a new precision calibration, you should use the SET option. You will be asked to set the device in true **geographical** direction of 0, 45, 90, 135, 180, 225, 270 and 315 degrees. The device should be positioned vertically, like being attached to the DPV. The Display shows:

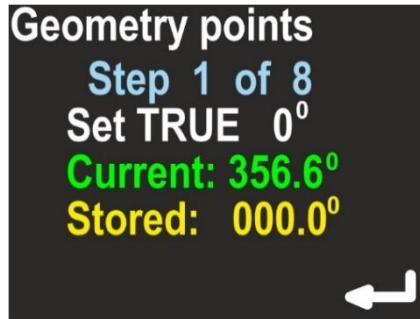

Current – Raw heading from magnetometer, without correction.

Stored – Stored value for this step.

The lower button will store the **Current** value as **Stored**, each time you press it. The upper button will guide you to the next step. On the last screen you can check, if this calibration improved the heading display. This screen is named 'Accuracy test' and will show you:

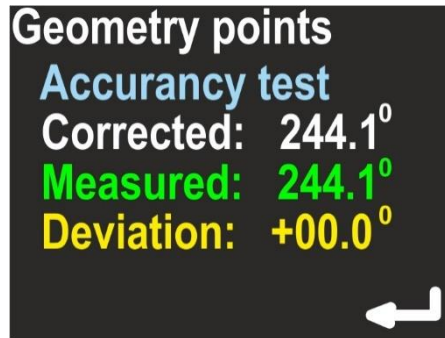

Corrected – Heading value with applied correction

Measured – Raw heading value from magnetometer

Deviation – Calculated correction; $\text{Corrected} = (\text{Measured} + \text{Deviation}) \bmod 360$.

If the corrected values are better than the measured values, press the lower button (ENTER) to store the results. If you press the upper button, no changes will be stored.

Caution: Beware of placing another compass near this device when performing this calibration, because it might affect the measurement and affects the calibration procedure.

Declination - Set magnetic declination, a constant value that will be added to the heading shown on the display (and to all position calculations). If the value is marked as E (East), the correction will be positive. When marked as W (West), the correction will be negative. The magnetic declination is a constant value, depending on your geographical region. It can be obtained from many sources.

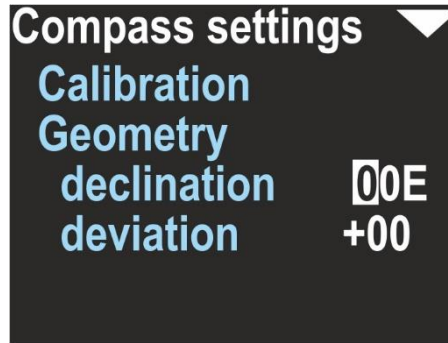

Deviation – Set magnetic deviation, a constant value that will be added to the heading shown on the display (and to all position calculations). The deviation is a constant value caused by magnetic elements near the navigation device, that cannot be removed. In most cases it will be set to 0.

Note



The compass heading on the device display (and the data recorded in memory) will use both **declination** and **deviation** coefficients. There is a common rule: **declination** is a matter of geographical location and **deviation** is caused by other equipment. That is why these two coefficients are separated.

22. Clear data

Clears all records from the internal memory. The user will be asked, if he really wants to perform this operation. It is recommended to power off and on the device after using this feature.

23. Factory reset

After using this option, all settings will be restored to factory values, and all other data will be lost.

You may want to use this option if:

- Diving records are invalid / incomplete or lost
- The device is not working correctly and you cannot find good settings

24. Exit

Exits the settings mode. The device returns to the main navigation screen.

25. Auxiliary software for Android® - installing

Go to Google Play store (<https://play.google.com/store>), and search for SEACRAFT CONSOLE application .



Our application will be marked with this icon : . You should download and install it on your device.

Minimum requirements for your mobile device :

Operating system	Google Android 5.0 or newer
Bluetooth link	Version 4.0 or above (4.2 recommended)
Internet connection	Required when displaying maps

Note : you may also need to switch on a 'Localization service' when using this application, if you have any troubles with displaying maps.

You will have to pair ENC3 console with your device only before first use.

Pairing procedure :

- switch on ENC3 console
- go to **MENU → SETUP → Send data**
- switch on Bluetooth receiver in your mobile device
- go to Bluetooth settings in your mobile device and scan for nearby devices; look for device named **SEACRAFT-XXXXXX** (i.e. SEACRAFT-904101), this name will be also shown on ENC3 screen
- click SEACRAFT-XXXXXX name and wait for pairing, no PIN is needed

Note : if you want to get data from another ENC3, you will have to manually unpair your present device first.

26. Auxiliary software for Windows® - installing

You may use this link for downloading software :

<https://mega.nz/#!qLghCQQb!plrLAIHiFGMOZfgmuNEQDEm8hfZKkpFRYdO3X6TqVOE> or you may ask our support (office@seacraft.eu) for the direct link to download it.

This link will be soon added to our webpage, in the DOWNLOAD section (www.seacraft.eu/download).

Minimum requirements for your computer :

Operating system	Microsoft Windows 10
Bluetooth link	Version 4.0 or above (4.2 recommended); not necessary when using USB cable
Internet connection	Required when displaying maps

Note



Bluetooth hardware should be present and switched on before running this application, if you plan to use wireless transmission with your ENC3.

When using USB cable, first go to **MENU** → **SETUP** → **Send data**, next connect the cable to PC.

27. Using auxiliary software

ENC3 auxiliary software looks and works almost identically on Windows and on Android. In this manual we will describe Windows version of this software. This software is common for ENC2 and ENC3 devices.

When you start ENC3 auxiliary software, you will see main program window as shown below:



In example above, you can see software version number **1.0.93.0**. You should always include this information when requesting help or reporting errors.

Please always try to get a most recent software version, and keep the program updated.

Some functions are in development stage and will not be described below until finished (marked as 'in development').

Four buttons below lead to main program functions. All menu items are shown in table below as "menu tree" :

Main window

Stored Routes	View and edit dive data / records
Import Routes	Download data into program
From File	Download data from other person (i.e sent via email)
From Bluetooth Device	Download data from ENC3 via Bluetooth
From Serial Device	Download data from ENC3 via USB cable
Configuration	
Units	Choose units for showing downloaded data
Upgrade via Bluetooth	Upgrade internal ENC3 firmware using Bluetooth connection
Upgrade via Serial	Upgrade internal ENC3 firmware using USB connection
Manual	<i>(in development)</i>
Clear data	Clear all downloaded data
Advanced	Other settings (see below)
Unlock PRO	Unlock some additional functions (see below)

You can navigate back in this program using button marked as "<<".

IMPORTING DATA FROM ENC3 TO PC/MOBILE DEVICE

To download data from ENC3, click **Import Routes** and then **From Device** button.

On Android, you have to pair ENC3 with your mobile device before this operation (or make sure it was paired before). On Windows pairing is done automatically.

When downloading data from ENC3, program screen will look like below :

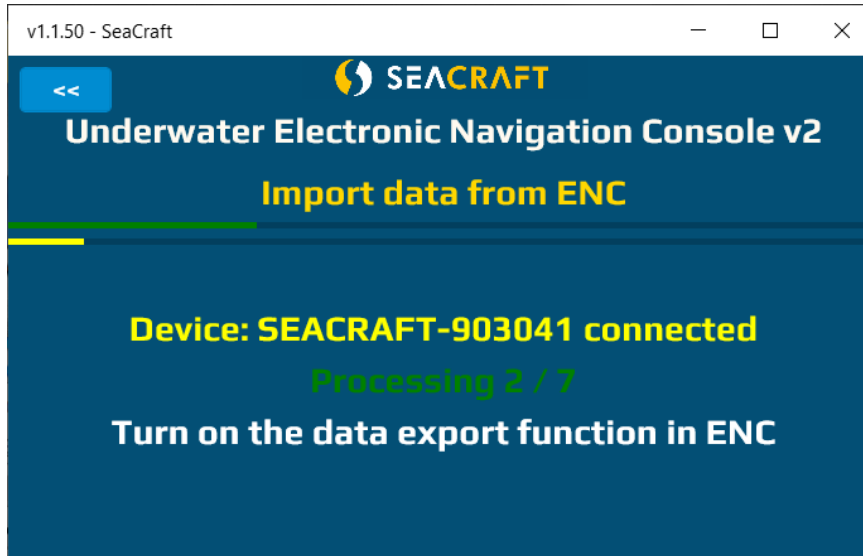

Green horizontal bar shows total progress of operation.

Yellow horizontal bar shows progress downloading current item.

Yellow text **Device: SEACRAFT-903041 connected** shows ENC3 name and status.

Green text **Processing 2/7** informs, that 2nd item of total 7 is now processed. When all items are downloaded, this field will show **TRANSFER COMPLETED**.

Then you can switch off ENC3 and start browsing your downloaded data. Click  button to go back to main screen.

Note



ENC3 device can hold up to 50 different routes inside. GPS data and swim data are recorded as separate files. So if you have 10 records inside your ENC, download screen can show you 10-20 items (10 items – no GPS data was recorded, 20 items – all 10 routes has GPS data)

VIEW / EDIT IMPORTED DATA

All imported data are available by clicking **Stored Routes** button on main screen.







v1.1.50 - SeaCraft

— □ ×

SEACRAFT

Underwater Electronic Navigation Console v2

1

Name	Points	Start At	Dist		Depth (m)		Speed (m/min)	
			(m)	Time	Max	Avg	Max	Avg
ALL	3		1470.3	1h08'	7.2	4.1	82	22
  002	368	19-06-26 11:59	293.4	0h14'	7.2	4.9	72	21
  001	122	19-06-26 11:27	168.8	0h04'	6.5	4.4	64	42
  000	846	19-06-12 13:04	1008.1	0h49'	7.2	3.8	82	21

2-3-4-5-6-7-8-9-10-11-12

- 1- Headers section. By clicking on each header you can sort data in table ascending or descending
- 2- Green anchor symbol means that this route was anchored (see further for more information)
- 3- Green marker symbol means that route has GPS data also
- 4- Route number. Notice that route no. 1 in ENC device is downloaded as item 000, route no. 2 – as 001, etc.
- 5- Total number of records in each route (1 record = 1 stored set of data : depth, speed, location, ...)
- 6- Route start time (time of the first record). Format is **YY-MM-DD hh:mm** .
- 7- Total travelled distance
- 8- Route time (time between first and last record in this route)
- 9- Maximum recorded depth
- 10- Average recorded depth
- 11- Maximum recorded speed
- 12- Average recorded speed

Note



This application always downloading only missing information from ENC3. If not all data was downloaded at first try, you can always repeat downloading procedure and missing items will be filled.

Sometimes not all data are downloaded at first time. ENC3 is much slower with serving the data, if compared to your PC which is grabbing it. If you find, that some of your records from ENC3 are missing in the PC program, just repeat the downloading process to complete it.

When you click on selected route, screen will show you detailed information about it :

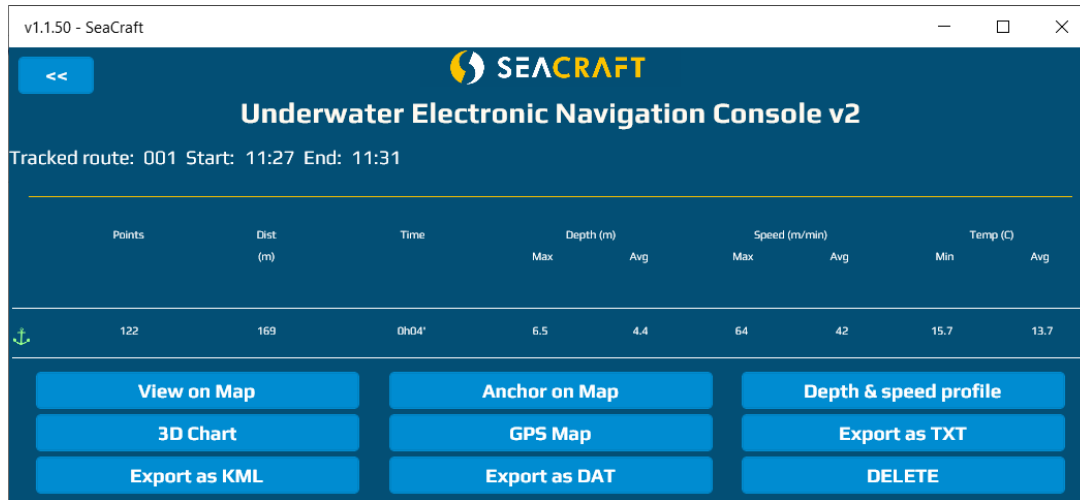

Buttons role:

DELETE – delete current (only one) route from this PC or mobile device.

Export as DAT – swim data (without GPS records) will be stored in native ENC3 format (for helpdesk or support purposes)

Export as TXT – swim data (without GPS records) will be stored as text CSV file (you can import it to any spreadsheet program for further calculations)

GPS map – shows all GPS records (only) on map – as points connected with lines

3D Chart – shows swim records as 3-dimensional graph

Depth & speed profile – shows in graphical form depth and speed data as shown below :

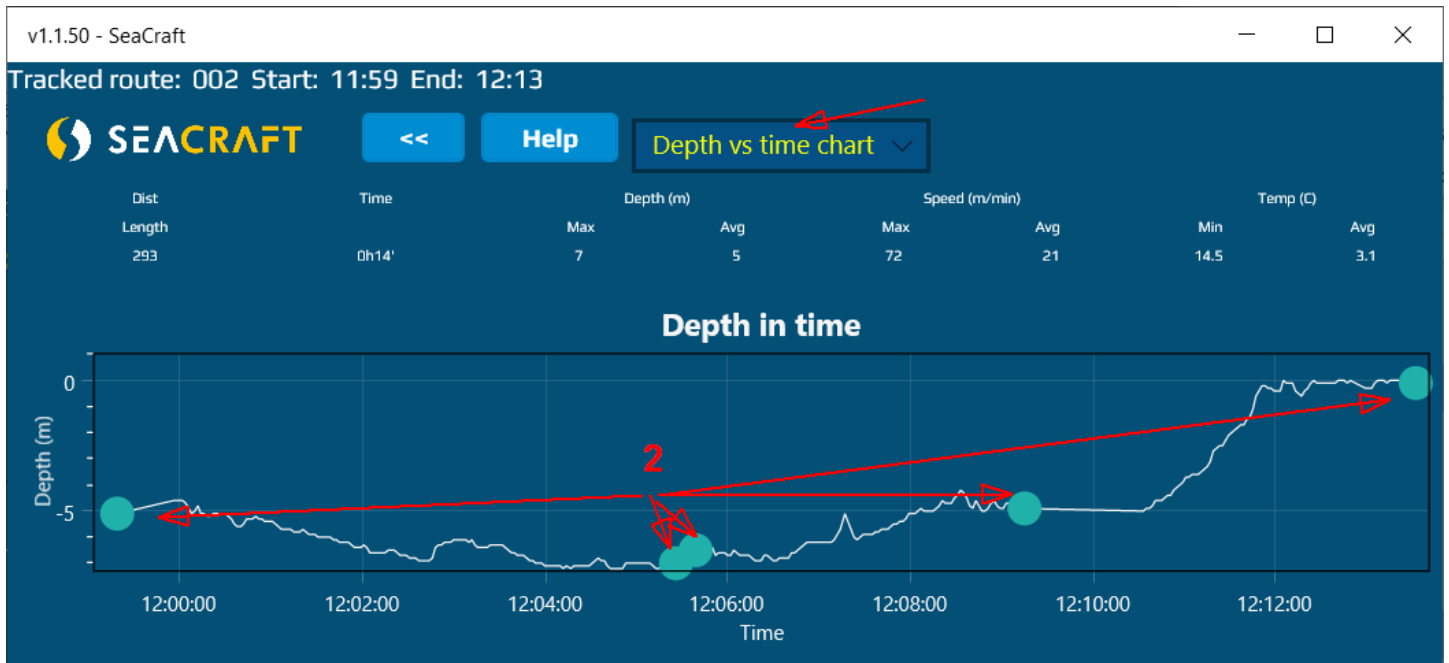

1 – with this field you can switch between 3 graphs : **depth vs time**, **depth vs distance** and **speed vs time**

2 – this blue point shows each marker (point where you switched between REC and HOLD state while using ENC3)

Anchor on map – ENC3 device records route as set of relative positions. If you want to show this route on any map, you have to manually set the “first point location” – by clicking it on the map. It should be this point, where you press REC first time. If you press this button, you will see the empty map. It’s recommended to click in any point of the map first. This will be the first (but invalid) anchor position. Then you may move the map by clicking and holding it. Use Zoom-in and Zoom-out controls to get appropriate scale for your operations.

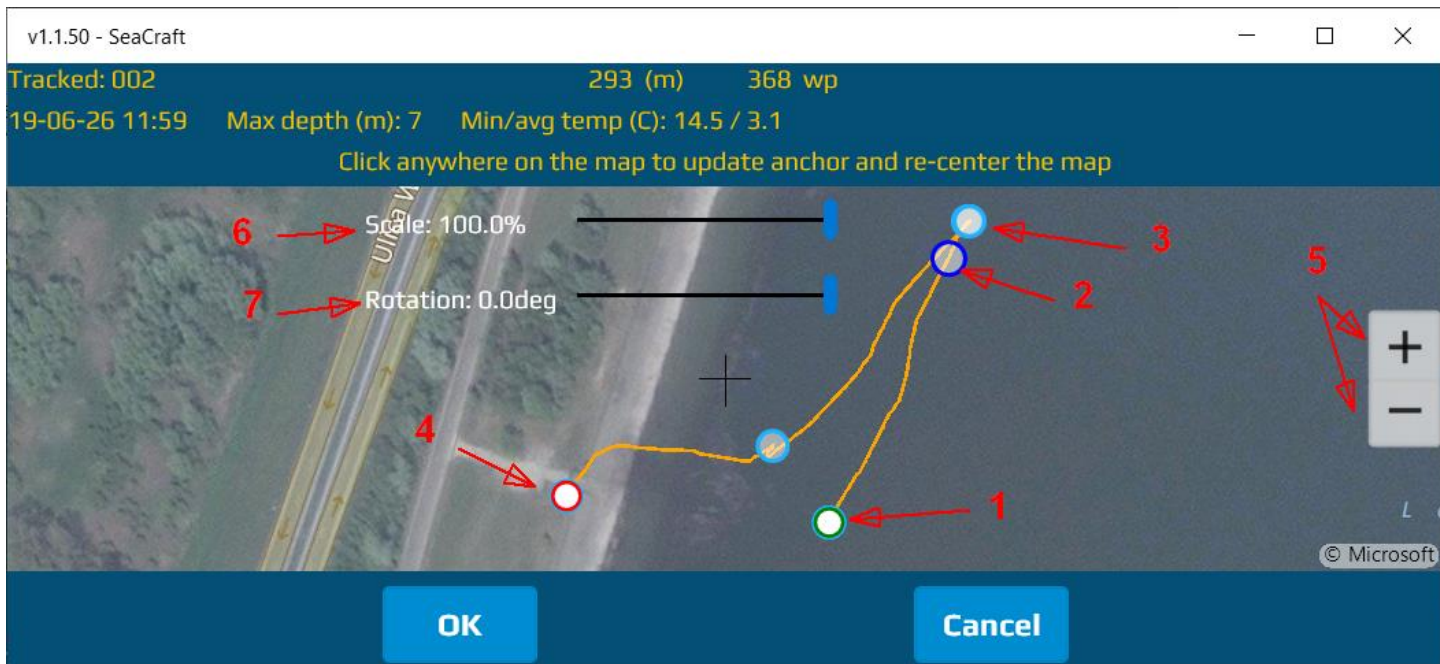

- 1- Route starting point (green circle)
- 2- Route max depth point (dark-blue circle)
- 3- Marker point (light-blue circle)
- 4- Route end point (red circle)
- 5- Zoom In/Out controls
- 6- Scale fit slider
- 7- Rotation slider

Note



You may want to use **Scale** slider if you had log sensor uncalibrated. In that case, distance recorded by ENC3 will differ from real value and this control can fix this problem.

You may want to use **Rotation** slider if ENC3 had constant, uncompensated compass deviation, or declination was not correctly set. In that case, ENC3 show (and recorded) a compass, or magnetic courses. For map plotting we need to use real headings (compass heading, corrected by deviation and declination), otherwise shown tracks will be invalid.

This features will take effect in map display and KML file export. Raw exported data (DAT, TXT format) are always 100% unchanged regarding to ENC3 records.

View on Map – allows to show current route on map. It looks almost the same as when anchoring route, but without Scale and Route controls.

CONFIGURATION OF AUXILIARY SOFTWARE

Units

This option allows to change display units, but in this application only. ENC3 has his own display units settings and it is independent.

Upgrade

Allows ENC3 firmware update (see further – chapter 28)

Manual

(in development)

Clear Data

This option allows to delete all data imported from ENC3 from this application database. This option does not affect internal ENC3 memory, only downloaded records.

Advanced

Please do not change this options from its default values, unless asked by our technical support.

Unlock PRO

This software can be used also with other version of ENC3 console, specialized for less common tasks. For this 'special' versions of ENC3 some additional settings are required and you may unlock it using this option. Ask our support for unlocking code, if you have this 'special' versions of ENC3 console. Users of regular ENC3 device will have no reasons to access this options.

28. ENC3 firmware update

To use this feature, you will have to get new firmware file. This file can be send to you from our support team via e-mail, after receiving your device serial number. You will have to copy received file to the device (PC or mobile device) when this auxiliary software is installed.

Before starting update process :

- Make sure ENC3 is charged at least to 50%
- Make sure your PC or mobile device is charged enough to work for 15 minutes or more
- Go away from any strong electromagnetic field sources, which can disturb wireless connection (microwaves, electric motors, etc.)
- switch on ENC3 device and go to the **MENU→SETUP→Send data** (inside ENC3), then connect the data cable between your ENC3 and your PC (if you're planning to use USB for the data transfer)
- Start auxiliary software and select **Configuration → Upgrade via Bluetooth** or **Configuration → Upgrade via Bluetooth** depending of you preferred communication medium
- Select ROM file which you received from us. **DO NOT try** to use any other file in this option.
- Make sure no other application on your PC or mobile device will disturb update process

If you make all this steps correctly, you will see screen like below :



and for a while ...



After all data was sent to the ENC3, display of your console will be switched off, and red LED diode above it will blink for 10 seconds. After that, your ENC3 should switch on automatically.

TROUBLESHOOTING FIRMWARE UPDATE

Symptom	Procedure
Update process hangs and progress bar doesn't increment for more than 1 minute	<ul style="list-style-type: none">- Press STOP on ENC3 device to break data transmission- Close PC / mobile application and start all update procedure again from the beginning
Firmware was not updated (software version shown in ENC3 didn't changed)	Update file was corrupted during transmission and rejected by ENC3. Repeat update procedure from the beginning.
Compass not working properly	Compass sensor was overcharged during update process. To fix it : <ul style="list-style-type: none">- Switch off ENC3, wait 10 seconds and connect to charger for 10 seconds, or <ul style="list-style-type: none">- Leave ENC3 switched on until battery is totally discharged, and then recharge ENC3

The update process can take 2-3 minutes when using software installed on Windows 10 PC (5-6 minutes when using Android devices).

IMPORTANT !

If you will have to break the update process, first use the lower button in your ENC to break transmission (this is 100% safe, always). After update, ENC will reboot. Check software version. If software version did not changed, you will have to repeat the update process (it happens sometimes, but second try is always successful).

29. Guidelines for attaching the ENC to DPVs

When using the navigation console with any DPV, you should carefully choose the mounting point for the device. An unfavorable placement may cause magnetic interferences from your vehicle elements (battery, engine) to the ENC compass sensor.

For a SEACRAFT® underwater vehicle, the recommended placement for the navigation device and its speed sensor is shown below:

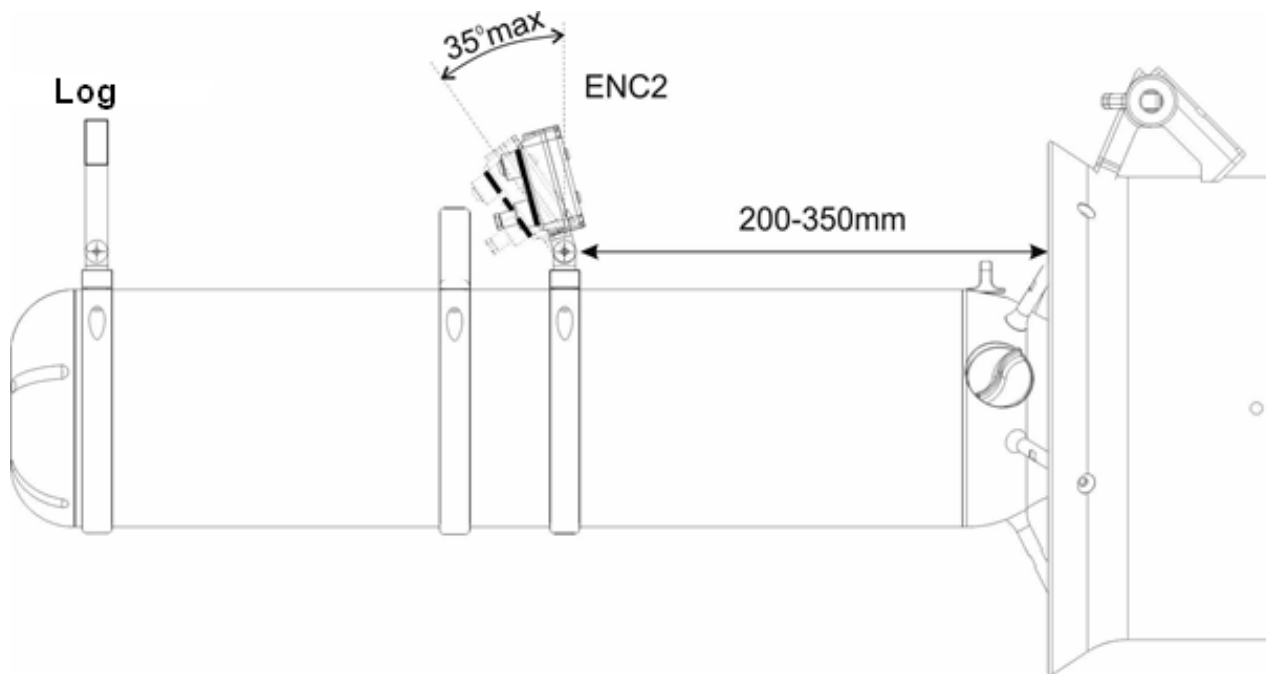

LIMITATIONS:

- ENC device should be placed at least 0,2 m (7,9") from any element containing ferromagnetic material (engine, battery), permanent magnets (engine, vehicle handles, speed sensor) or electrical wires connecting the battery with the motor. If this rule is violated, compass indications may be incorrect.
- Compass indications may be less stable when ENC tilt exceeds 35° (from vertical position). If you include your vehicle lean, you should not exceed 35° inclination of ENC device vs vehicle body (see picture above).
- Log sensor should be placed away from any elements that can disrupt the flow of water. Front of vehicle is almost always the best choice. Have in mind propeller "sucking" effect, and avoid placing it in the water intake area.

If you need to place ENC device on some other kind of underwater vehicle, you have to find best mounting points on your own, using picture above as guidance.

In order to maintain the correct compass accuracy, it is recommended to always calibrate the compass before diving. Indicated by the compass the direction is calculated from the device measured by the magnetic components of the Earth measured by the magnetometers. These components change depending on the location, local geological conditions (eg the presence of ferromagnetic minerals) and are subject to periodic changes. Large ferromagnetic elements, eg shipwreck, reinforced concrete port quay or steel elements buried in the bottom, also very strongly affect the work of the compass.

A poorly calibrated compass or its disturbed operation can cause significant errors. In the case of a route with a length of 1 km, 5 degrees of compass error will result in an error in the calculation of the target of almost 88 m.

One should also remember about the differences between the magnetic direction indicated by the magnetic compass and the geographical direction that can be read from the maps. The difference between these courses is called magnetic declination and depends on the location. The device allows you to set the magnetic declination and offset this difference.

In order to optimally use the device, it is recommended to familiarize with the theory and principles of navigation in detail.

The log sensor is a precise electromechanical device and must be protected against mechanical impacts and contamination. After the dive, it is recommended to gently rinse with fresh water to cleanse any remaining vegetation or mineral impurities. If it is necessary to make measurements with full precision, it is recommended to calibrate the log every time.

30. Troubleshooting

Symptom	Cause	Solution
Device cannot be switched on. Display is blank and no other reactions is observed.	Excessive battery discharge.	Start charging battery for at least 30 minutes before attempt to switch on the device. After few minutes, the red led the will start blinking.
	Broken device (flooded, charged from improper source), does not react when charging	Factory service needed.
Device is switching on and off continuously.	One of the internal sensors may be damaged or battery is broken.	Connect the charger for 1 minute. If this will not help, allow the device to discharge its battery and to switch off. Wait 1 hour, and try to charge it again. If this will not help, return the device for service.
When switched on, the device shows "Battery is low!" message and switches off.	The battery is discharged too much.	Charge the device.
The charging process never ends. Battery charge level never reach 90%.	Broken battery.	Return the device for service.
	Damaged charging cable or dirt/rust on its connector.	Clean the charger connector. Make sure it is not cut or damaged.
	Charging source too weak.	Try another charger. You may use the USB port of a laptop/PC.
The depth indication is 0 and never changes. Depth shown is invalid. The device is not switching on automatically when immersed in water.	Defective pressure sensor.	Go to Settings / Pressure/salin. If the pressure is near 0, the sensor is defective and factory service is needed.
	Pressure sensor gap filled with dirt or mud.	Wash the device using a mild stream of warm fresh water, until the problem is gone.

External sensor is connected, but no speed is shown.	Sensor connector misfit, broken or rusted.	Disconnect the sensor plug, wash and/or clean the connector, connect it again.
	The device is switched do INERTIAL operation.	Go to Settings / Log/Speed, and make sure EXT is set to 'Active Log'.
Compass is showing improper heading.	Calibration required.	Perform the calibration as described in chapter 13.1 and 13.2
	Strong external magnetic field near the device.	Try to remove the magnetic and ferromagnetic elements from the vicinity of the navigation device. Move the navigation device to another location.
	Defective sensor	Return the device for service.
	Compass sensor was overcharged.	Power off the device. Wait 10 seconds. Connect charger for 10 seconds. Check again compass behavior.

Note



Recommended intervals to re-check the required accuracy of the product - 36 months from the date of purchase and the next every 24 months.

31. Before each dive...

Make sure that battery is charged enough. Power on device and check all important settings.

In order to connect the log to the device, check the state of the plug and socket, clean any impurities, check the o-rings, apply a delicate layer of silicone grease and gently but firmly tighten.

Before diving you have to check, if output socket (in the back) is well tightened. Also you have to make sure, that none of the sealing o-rings is broken or missing.

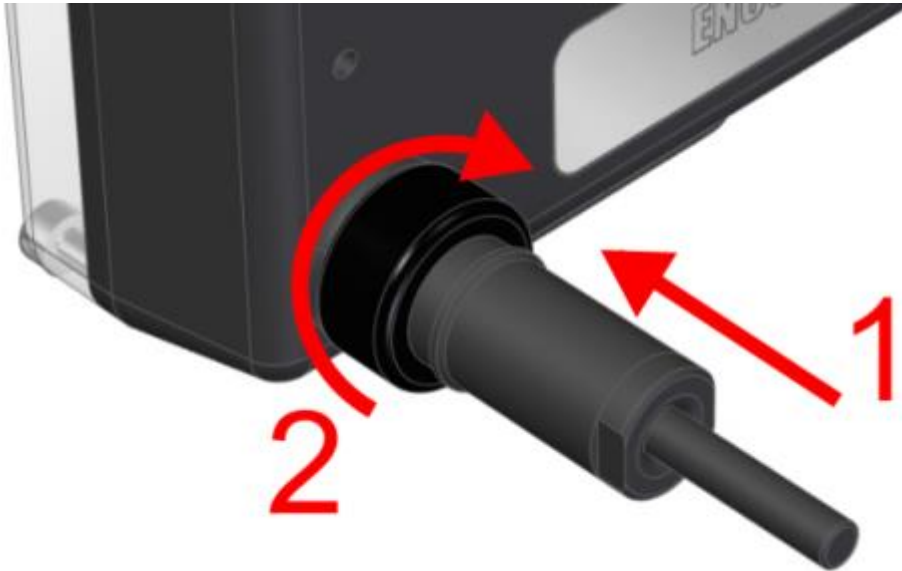

Proper way to fit the connector :

1. Push the plug into the socket as far as it can move
2. Turn the nut clockwise until you feel the resistance



EEA DECLARATION OF CONFORMITY

Product model/product:

Electronic Navigation Console with all unique identification numbers.

Name and address of the manufacturer or his authorised representative:

Marine Tech SA
Zwirki i Wgury 17 str.
38-400 Krosno, Poland

Subject of declaration: Electronic Navigation Console with all unique identification numbers.

The abovementioned subject of the following declaration is in conformity with the relevant EU harmonisation legislation:

EN 13319:2002

Additional information:

- Any unauthorized modification will invalidate this declaration;
- This declaration is not a guarantee of performance characteristics.

Signed for and on behalf of: Marine Tech SA

Krosno, 10.01.2019

(place and date)

(name, signature)

MARINE TECH Spółka Akcyjna

38-400 Krosno

ul. Zwirki i Wgury 17

KRS: 0000557411

NIP: 7811910188 REGON: 361492147



MARINE TECH SA
38-400 Krosno, ul. Żwirki i Wigury 17, POLAND
info@seacraft.eu
www.seacraft.eu